

WIRELESS REMOTE CONTROL RCN-E2,RCN-EK2 USER'S MANUAL

USER'S MANUAL	ENGLISH
MANUEL DE L'UTILISATEUR	FRANÇAIS
ANWENDERHANDBUCH	DEUTSCH
ISTRUZIONI PER L'USO	ITALIANO
MANUAL DEL PROPIETARIO	ESPAÑOL
GEBRUIKERSHANDLEIDING	NEDERLANDS
MANUAL DO UTILIZADOR	PORTUGUÊS
ΟΔΗΓΙΕΣ ΧΡΗΣΗΣ	ΕΛΛΗΝΙΚΑ
РУКОВОДСТВО ПО ЭКСПЛУАТАЦИИ	РУССКИЙ
KULLANIM KILAVUZU	TÜRKÇE



This air-conditioner complies with following directive.

Machinery 2006/42/EC
Low Voltage 2014/35/EU
EMC 2014/30/EU
Pressure Equipment 2014/68/EU
RoHS 2011/65/EU
Ecodesign 2009/125/EC
CE marking is applicable to the area of 50 Hz power supply.

Ce climatiseur est conforme aux directives suivantes.

Machines 2006/42/CE
Basse tension 2014/35/UE
CEM 2014/30/UE
Équipements sous pression 2014/68/UE
RoHS 2011/65/UE
Écoconception 2009/125/CE
La marque CE s'applique aux régions alimentées en courant de 50 Hz.

Diese Klimaanlage erfüllt die folgende Richtlinie.

Maschinen 2006/42/EC
Niederspannung 2014/35/EU
EMV 2014/30/EU
Druckgeräte 2014/68/EU
RoHS 2011/65/EU
Ökodesign 2009/125/EC
Die CE-Marke gilt für Bereiche mit einer Netzstromversorgung von 50 Hz.

Questo condizionatore d'aria è conforme alla seguente direttiva.

Macchinario 2006/42/CE
Bassa tensione 2014/35/UE
EMC 2014/30/UE
Apparecchiature a pressione 2014/68/UE
RoHS 2011/65/UE
Ecodesign 2009/125/CE
Il marchio CE è applicabile alla fascia di alimentazione 50 Hz.

Este aire acondicionado cumple con la siguiente directiva.

Máquinas 2006/42/CE
Baja tensión 2014/35/EU
EMC 2014/30/UE
Equipos a presión 2014/68/UE
RoHS 2011/65/UE
Ecodiseño 2009/125/CE
La indicación CE sólo corresponde al área de suministro eléctrico de 50 Hz.

Deze airconditioner voldoet aan de volgende richtlijn.

Machine 2006/42/EC
Laagspanning 2014/35/EU
EMC 2014/30/EU
Drukapparatuur 2014/68/EU
RoHS 2011/65/UE
Ecodesign 2009/125/EC
CE-markering is van toepassing op het gebied met een netstroom van 50 Hz.

Este ar condicionado está em conformidade com as seguintes directivas.

Máquinas 2006/42/CE
Baixa tensão 2014/35/UE
EMC 2014/30/UE
Equipamentos sob pressão 2014/68/UE
RoHS 2011/65/UE
Concessão ecológica 2009/125/CE
A marca CE aplica-se à zona de fornecimento de energia a 50 Hz.

Το συγκεκριμένο κλιματιστικό συμμορφώνεται προς καθεμιά από

τις οδηγίες που ακολουθούν.
2006/42/ΕΚ περί μηχανημάτων
2014/35/ΕΕ περί χαμηλής τάσης
2014/30/ΕΕ περί ηλεκτρομαγνητικής συμβατότητας (EMC)
2014/68/ΕΕ περί εξοπλισμού υπό πίεση
2011/65/ΕΕ RoHS
2009/125/ΕΚ περί οικολογικού σχεδιασμού
Το σήμα CE ισχύει μόνον σε περιοχές όπου η τροφοδοσία είναι 50 Hz

PJZ012A128



201612

Thank you very much for your purchasing the WIRELESS REMOTE CONTROL for our packaged air conditioner.

This user's manual describes cautions for safety. Please read this manual carefully before use in order to operate the unit properly.

Keep this manual, after reading, at a safe place where you can consult it whenever it is necessary.

When the ownership of the unit is changed, please be sure to transfer this manual and the "Installation Manual" to a new owner.

It is not recommended for a user to install or move the unit by the user's own discretion. (Safety or functions may not be assured.)

ENGLISH



Contents

■ 1. BEFORE YOU USE.....	2
■ 2. NAMES AND FUNCTIONS OF REMOTE CONTROL BUTTON.....	4
■ 3. HOW TO OPERATE	7
■ 4. CURRENT TIME SETTING PROCEDURE	8
■ 5. ON - TIMER OPERATION BY CLOCK.....	8
■ 6. OFF - TIMER OPERATION BY CLOCK	8
■ 7. SLEEP TIMER OPERATION	9
■ 8. PROGRAM TIMER OPERATION	9
■ 9. INDOOR FUNCTION SETTINGS (Available only with master wireless receiver)	10
■ 10. BACKUP SWITCH OPERATION	10
■ 11. CHECK INDICATION	11
■ 12. FILTER SIGN	12





1. BEFORE YOU USE

Safety precautions

- Please read the precautions written here carefully to operate the unit properly. You are required to observe these fully because every item of these instructions is important for safety.

 WARNING	Failure to follow these instructions may result in serious consequences such as death, severe injury, etc.
 CAUTION	Failure to follow these instructions may cause injury, property damage or, serious consequences depending on.

- The following pictograms are used in the text.

	Never do.		Always follow the instructions given.
	Absolutely keep water away.		Absolutely keep wet hands away.

- Keep this manual at a safe place where you can consult with whenever necessary. Show this manual to installers when moving or repairing the unit. When the ownership of the unit is transferred, this manual should be given to a new owner.
- **Electrical wiring work must be implemented only by qualified specialists.**

WARNING

 **Consult your dealer or a professional contractor to install the unit.**
Improper installation made on your own may cause electric shocks, fire or dropping of the unit.





 **Consult your dealer when moving, disassembling or repairing the unit. Never modify the unit.**
Improper handling may result in injury, electric shocks, fire, etc.

 **Avoid using combustible substances (hair spray, insecticide, etc) near the unit. Do not use benzene or paint thinner to clean the unit.**
It could cause cracks, electric shocks or fire.



Stop operation under abnormal situation.
 If continued, it could result in break-down, electric shocks, fire, etc.
If any abnormal condition (burnt odor etc.) occurs, stop operation, turn off the power switch and consult your dealer.

 **This appliance can be used by children aged from 8 years and above and persons with reduced physical, sensory or mental capabilities or lack of experience and knowledge if they have been given supervision or instruction concerning use of the appliance in a safe way and understand the hazards involved.**

⚠ CAUTION

-  **Do not use or let use the unit or remote control as play equipment.**
Improper operations could cause ill health or health disorder.
-  **Never disassemble the remote control.**
If you touch internal parts accidentally, you could get electric shocks or cause trouble.
-  **Do not wash the remote control with water or liquid.**
It could cause electric shocks, fire or break-down.
-  **Do not touch electric parts or operate buttons or screens with wet hands.**
It could cause electric shocks, fire or break-down.
-  **Do not dispose the remote control by yourself.**
It could destruct the environment. Ask your dealer when it is necessary to dispose the remote control.

Note

-  **The remote control should not be putted where it is exposed to direct sunlight or the ambient temperatures become higher than 40°C or lower than 0°C.**
It could cause deformation, discoloration or break-down.
-  **Do not use benzene, paint thinner, wipes etc. to clean the remote control.**
It could discolor or break-down the remote control. Wipe it with a piece of cloth which is squeezed tightly after wetting with diluted neutral detergent. Finish up the cleaning by wiping with a piece of dry cloth.
-  **Do not tap the remote control buttons or screen with pointed objects.**
It could damage or cause break-down.

Precautions for waste disposal



Your Air Conditioning product may be marked with this symbol. It means that waste electrical and electronic equipment (WEEE as in directive 2012/19/EU) should not be mixed with general household waste. Air conditioners should be treated at an authorized treatment facility for re-use, recycling and recovery and not be disposed of in the municipal waste stream. Please contact the installer or local authority for more information.

Remote control specifications

Item	Description
Product dimensions	60 (W) x 167 (H) x 24 (D) mm (not including protruded section)
Weight	0.11 kg
Power supply	DC 3.0 V
Usage environment	Temperature: 0 to 40 °C
Material	Casing: ABS

2. NAMES AND FUNCTIONS OF REMOTE CONTROL BUTTON

INDICATION BOARD AND BACKUP SWITCH

- Ceiling suspended (FDE)
- Ceiling cassette -4 way- (FDT)
- Ceiling cassette -4 way Compact- (FDTC)
- Ceiling cassette -1 way- (FDTS)

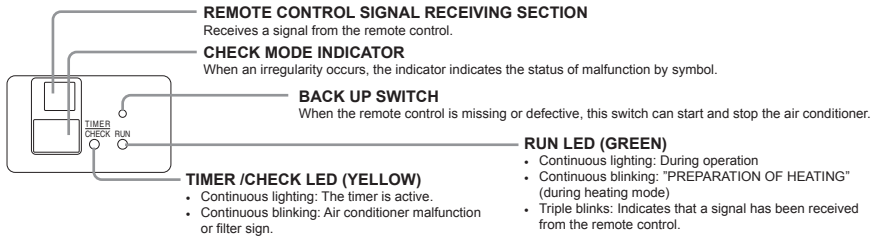

RCN-KIT4-E2

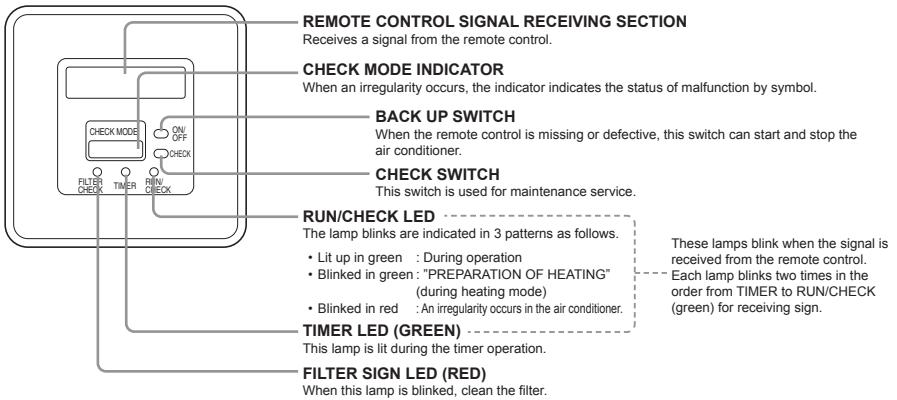

Ceiling cassette -2 way- (FDTW)

Floor standing -2way- (DFW)

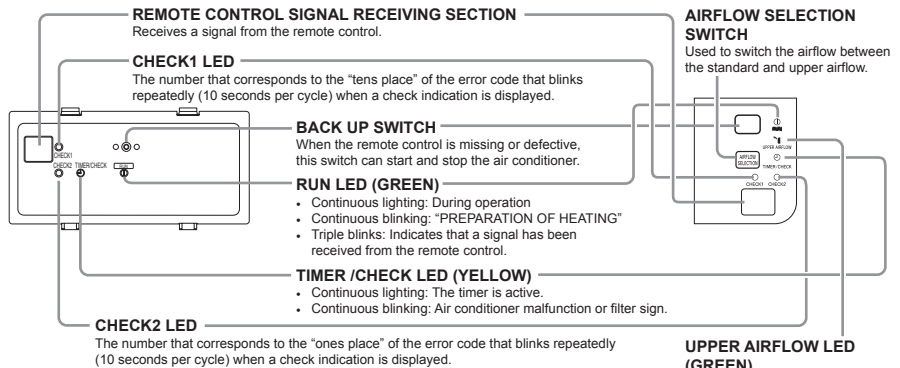

Wall mounted (FDK)

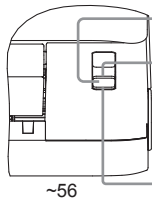

BACK UP SWITCH

When the remote control is missing or defective, this switch can start and stop the air conditioner.

RUN LED (GREEN)

- Continuous lighting: During operation
- Continuous blinking: "PREPARATION OF HEATING"
- Triple blinks: Indicates that a signal has been received from the remote control.
- The number that corresponds to the "tens place" of the error code that blinks repeatedly (10 seconds per cycle) when a check indication is displayed.

TIMER LED (YELLOW)

- Continuous lighting: The timer is active.
- Continuous blinking: Filter sign
- The number that corresponds to the "ones place" of the error code that blinks repeatedly (10 seconds per cycle) when a check indication is displayed.

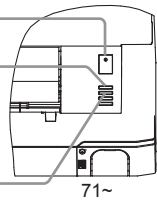

WIRELESS REMOTE CONTROL

All displays are described in the liquid crystal display for explanation

Display section

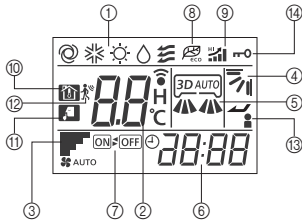

① OPERATION MODE display	Indicates selected operation mode.
SET TEMP display	Indicates set temperature.
② SLEEP TIMER time display	Indicates the amount of time remaining on the sleep timer.
Indoor function setting number display	Indicates the setting number of the indoor function setting.
③ FAN SPEED display	Indicates the selected air flow volume.
④ UP/DOWN AIRFLOW display	Indicates the up/down louver position.
⑤ LEFT/RIGHT AIRFLOW display	Indicates the left/right louver position. (RCN-EK2 only)
⑥ Clock display	Indicates the current time. If the timer is set, the ON TIMER and OFF TIMER setting times are indicated.
⑦ ON/OFF TIMER display	Displayed when the timer is set.
⑧ ECO mode display	Displayed when the energy-saving operation is active.
⑨ HI POWER display	Displayed when the high power operation is active.
⑩ NIGHT SETBACK display	Displayed when the home leave mode is active.
⑪ SILENT display	Displayed when the silent mode control is active.
⑫ Motion sensor display	Displayed when the infrared sensor control(motion sensor control) is enabled.
⑬ Anti draft setting display	Displayed when anti draft setting is enabled.
⑭ Child lock display	Displayed when child lock is enabled.

Operation section

Transmitter: Sends signal to the air conditioner.

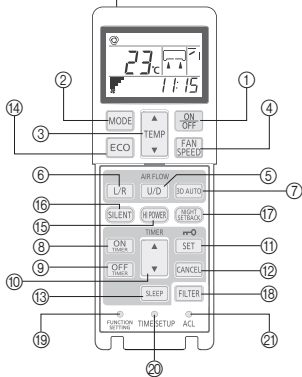

① ON/OFF button	When this is pressed once, the air conditioner starts to operate and when this is pressed once again, it stops operating.
② MODE button	Every time this button is pressed, displays switch as below
③ TEMP button	Change the set temperature by pressing ▲ or ▼ button.
④ FAN SPEED button	The fan speed is switched in the following order: 1-speed → 2-speed → 3-speed → 4-speed → AUTO → 1-speed.
⑤ U/D button	Used to determine the up/down louver position.
⑥ L/R button	Used to determine the left/right louver position. (RCN-EK2 only)
⑦ 3D AUTO button	Used to switch whether or not to enable or disable 3D AUTO mode. (RCN-EK2 only)
⑧ ON TIMER button	Used to set the ON TIMER.
⑨ OFF TIMER button	Used to set the OFF TIMER.
⑩ SELECT button	Used to switch the time when setting the timer or adjusting the time. Used to switch the settings of the indoor function.
⑪ SET button	Used to determine the setting when setting the timer or adjusting the time.
⑫ CANCEL button	Used to determine the settings of the indoor function. When press and hold SET button ,Child Lock is enabled.
⑬ CANCEL button	Used to cancel the timer setting.
⑭ SLEEP button	Used to set the sleep timer.
⑮ ECO button	Pressing this button starts the energy-saving operation. Pressing this button again cancels it.
⑯ HI POWER button	Pressing this button starts the high power operation. Pressing this button again cancels it.
⑰ SILENT button	Pressing this button starts the silent mode control. Pressing this button again cancels it.
⑱ NIGHT SETBACK button	Pressing this button starts the home leave mode. Pressing this button again cancels it.
⑲ FILTER button	Pressing this button resets FILTER SIGN.
⑳ FUNCTION SETTING switch	Used to set the indoor function.
㉑ TIME SETUP switch	Used to set the current time.
㉒ ACL switch	Used to reset the microcomputer.

WIRELESS REMOTE CONTROL HANDLING PROCEDURE

REPLACING THE BATTERIES

If the following occurs, the batteries are exhausted. Replace them with new ones.

- When the signal is transmitted, the air conditioner does not display reception.
- The display fades away or does not show anything.

■ How to insert batteries

- ① Detach the back lid.
- ② Insert the batteries. (two AAA batteries)
- ③ Reattach the back lid.
- ④ Adjust the current time.

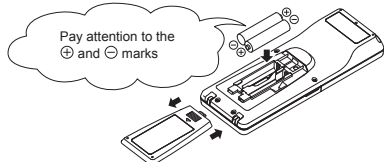

SETTING AFTER BATTERY REPLACEMENT

- When batteries are replaced, the remote control setting, indoor function setting, and time display are reset to the default. After replacing batteries, set them again to the preferred settings.

Change remote control setting

Function	Description	Switching method
Operation mode AUTO	Switches the AUTO mode between Enable and Disable.	MODE button While holding down each button, turn the power on or press the ACL switch.

Indoor function settings (page 10) / CURRENT TIME SETTING PROCEDURE (page 8)

ABOUT BATTERIES

- The recommendable effective period of a battery is about 6 to 12 months. (It depends on the usage.)
- The recommendable effective period is printed on the battery. This may be shorter due to manufacturing time of the unit.
However the battery may be still working in order after expiry date.
- The batteries packaged with the remote control are supplied in order to check operating conditions when usage begins, and subsequently, the life of these batteries may be shorter than that of new batteries.

ATTENTION

- When replacing batteries, replace with two new AAA batteries at the same time. (Alkaline batteries are recommended.)
- Do not mix old and new batteries or types of batteries (for example, manganese and alkaline batteries).
- Do not use rechargeable batteries.

▲ CAUTION CAUTIONS ON SWITCH OPERATIONS

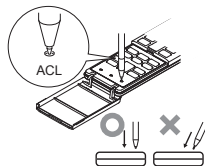

- When operating the "FUNCTION SETTING", "TIME SET UP", or "ACL" switches, press it straight downward using an object with a short pointed end such as a ballpoint pen. Do not press those switches forcefully at an angle using an object with a long and sharp end such as a mechanical pencil. Otherwise, the buttons may not pop up to their original positions.

HOW TO OPERATE

- If you press each button on the wireless remote control while pointing it at the signal receiver of the air conditioner body, a signal is sent. When the signal has been received without a problem, the RUN indicator LED blinks.

ATTENTION

- The buttons on the remote control must be operated carefully and securely.

If an error occurs on the display of the remote control

- Press the ACL switch with a ballpoint etc. Press the ACL switch to reset to the time set up mode. Set the time correctly.

ABOUT REMOTE CONTROL HOLDER

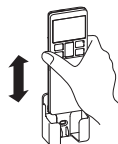

- The remote control can be mounted on the wall or pillar with the remote control holder.
Slide from the upper part of the holder to place or take out the remote control.

ATTENTION

- If the remote control signal receiver is exposed to direct sunlight or strong light, the receiver may not be able to receive a signal. In this case, block the sunlight or dim the light.
- Do not block the signal between the remote control and the remote control signal receiver.
- Do not point the air conditioner wireless remote control at devices such as a TV set that have their own wireless remote control.
- The remote control must be handled carefully.
- Remove the batteries when the remote control is not used for a long time.
- Even if the remote control is not found or damaged, you can operate the air conditioner with itself. See "10. BACKUP SWITCH OPERATION" on page 10.

3. HOW TO OPERATE

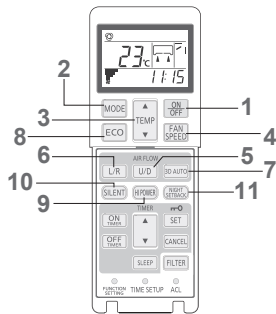

ATTENTION

- Turn on the power supply of both indoor/outdoor units for six hours before starting the unit to protect the units. (The crankcase is conducted and the compressor is heated) Do not turn off the power supply. (The crankcase heater is conducted while the compressor is stopped, preventing failure of the compressor due to accumulation of liquid refrigerant by keeping the compressor warm.)
- The operation of remote control must be performed slowly and steadily.

■ Guideline of room temperature setting

COOL 26 to 28°C
 DRY 21 to 24°C
 HEAT 22 to 24°C
 FAN TEMP setting is unnecessary

- Operation mode can be changed even when the unit stops.
- If you operate under the same condition (operation mode, set temperature, air flow, louver) just follow step 1, no other operations are necessary. The conditions which were set previously are indicated on the remote control.

OPERATION

1. Press ON/OFF button.

The operation display light (Green) turns on, and the operation starts.

2. Press MODE button.

The mode will change in the following order by pressing the button.

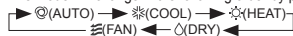

3. Press TEMP button.

Set temperature by pressing ▼ or ▲ button.

4. Press FAN SPEED button.

The fan speed is switched in the following order: 1-speed → 2-speed → 3-speed → 4-speed → AUTO and back to 1-speed.

5. Press the U/D button.

The up/down airflow changes as shown below each time the button is pressed.



NOTICE

- The louver movement does not match the display when the louver is swinging. This is not an error.
- The louver is set to horizontal swing mode to prevent you from being exposed directly to cold air during heat preparation or heat defrosting. (The set position shown on the display of the remote control does not change.)
- If you select the swing mode while the anti draft setting is enabled, the airflow is set to the horizontal direction.

ATTENTION

Do not set the swing louver downward for a long period of time when the cool mode is active. Otherwise, any dew that has formed on the side panel may drop. (In case of FDE)

6. Press the L/R button. (RCN-EK2 only)

The left/right airflow changes as shown below each time the button is pressed.

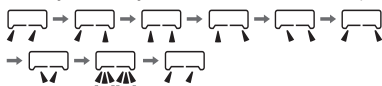

NOTICE

- The louver movement does not match the display when the louver is swinging. This is not an error.
- When there is a wall on the left of the air conditioner, we recommend that the airflow be directed to the right, and when there is a wall on the right of the air conditioner, direct the airflow to the left.



Left-aligned Installation



Right-aligned Installation

7. Press the 3D AUTO button. (RCN-EK2 only)

Switch whether or not to enable or disable 3D AUTO mode. 3D AUTO mode automatically controls the fan speed or airflow direction, which helps efficiently air condition the entire room.

NOTICE

- You cannot switch the up/down airflow or left/right airflow in 3D AUTO mode. When changing, cancel 3D AUTO mode.
- If 3D AUTO is selected while an FDK model with the switchable left/right airflow function is connected to an indoor unit without the switchable left/right airflow function, the airflow direction of the model that does not have this function is set to the direction that was selected before 3D AUTO mode was enabled.
- The left/right airflow switching or 3D AUTO cannot be operated from SC-SL2, SC-SL3, or SC-SL4. Even if the airflow direction is changed from SC-SL2, SC-SL3, or SC-SL4 during 3D AUTO mode, 3D AUTO is not canceled.

8. Press the ECO button.

Start or cancel the energy-saving operation. (In the cool, heat, or auto mode only) The energy-saving mode automatically controls the performance depending on the outdoor temperature, setting the standard temperature to 28°C in the cool mode and 22°C in the heat mode. This enables the energy-saving operation without compromising room comfort.

9. Press the HI POWER button.

Start or cancel the high power operation. (In the cool or heat mode only) The high power operation quickly sets the room temperature to a comfortable level. This mode accelerates the operation performance for 15 minutes, and automatically returns to the normal mode after that.

NOTICE

- When the system is connected to a centralized device, using the centralized device to specify the set temperature or fan speed during high power operation will cancel high power operation. In that case, the set temperature or fan speed specified using the centralized device may not be applied.
- High power operation cannot be used if 4-speed is "disabled" using the indoor unit or remote control.

10. Press the SILENT button.

Start or cancel the silent mode control. The silent mode preferentially controls the outdoor unit taking quiet operation into consideration.

11. Press the NIGHT SETBACK button.

Start or cancel the home leave mode. The home leave mode is a function that prevents the room temperature from becoming significantly high or low while you are not home. By factory default, home leave mode is as follows. Each setting can be changed by connecting the eco touch remote control.
 Determine temp rule in cooling: 35°C,
 Determine temp rule in heating: 0°C,
 Set temp rule in cooling: 33°C,
 Set temp rule in heating: 10°C,
 Fan speed rule in cooling: 1-speed,
 Fan speed rule in heating: 1-speed

NOTICE

When the system is connected to SC-SL4, using SC-SL4 to select an indoor unit and to start or cancel home leave mode links all units connected to the wireless receiver and starts or cancels home leave mode.

Stop

Press ON/OFF button.

NOTICE

When the system is connected to a centralized device or wired remote control, the functions that have been locked using a centralized device or wired remote control are not locked on the wireless remote control side.

4. CURRENT TIME SETTING PROCEDURE

The timer is set based on the current time. Adjust the current time correctly at first of all.

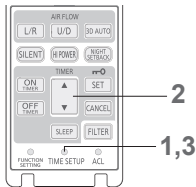

[EXAMPLE] 13:00 setting

1. Press TIME SET UP switch.

Press it with the tip of ballpoint etc. The time display blinks and can be set to the current time.

2. Press ▼ or ▲ button to adjust to 13:00.

If ▼ or ▲ button is pressed during the blinking, fast-forward or fast-backward can be done.

3. Press TIME SET UP switch.

The display changes from blinking to steady lighting and the setting is completed.
(Press within 60 seconds)

5. ON - TIMER OPERATION BY CLOCK

Operation is started at the setting time.

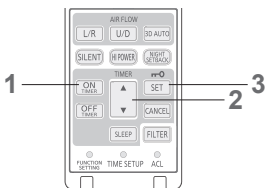

[EXAMPLE] If you would like to start the operation at 8:00

1. 1 Press ON TIMER button.

ON TIMER display **ON** blinks.

2. Press ▼ or ▲ button to adjust to 8:00.

Displayed time will be changed by 10 minutes by pressing the buttons.

3. Press SET button.

- ON TIMER display **ON** changes from blinking to steady lighting and the setting is completed.

(Press within 60 seconds)

- TIMER/CHECK display lamp of the receiver is lit.

- At 8:00, TIMER display lamp turns off and the air conditioner will start operating.

- **In case the ON TIMER is set while the air conditioner is in operation, it will be stopped and ready for restart at the setting time.**

- **Cancellation**

- Press CANCEL button to turn off the TIMER display and timer is canceled.

- After TIMER setting, if ON/OFF button is pressed before the setting time, TIMER display turns off and the TIMER is canceled.

- **Time change**

- Press ON TIMER button to set again.

6. OFF - TIMER OPERATION BY CLOCK

Operation is stopped at the setting time.

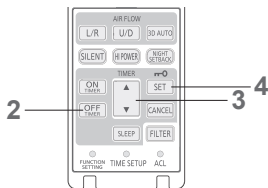

[EXAMPLE] If you would like to stop the operation at 21:00

1. Press ON/OFF button when the air conditioner stops.

The air conditioner starts to operate.

2. Press OFF TIMER button.

OFF TIMER display **OFF** blinks.

3. Press ▲ or ▼ button to adjust to 21:00.

Displayed time will be changed by 10 minutes by pressing the buttons.

4. Press SET button.

- OFF TIMER display **OFF** changes from blinking to steady lighting and the setting is completed.

(Press within 60 seconds)

- TIMER/CHECK display lamp of the receiver is lit.

- At 21:00, TIMER display lamp turns off and the air conditioner will stop operating.

- **Cancellation**

- Press CANCEL button to turn off the TIMER display and timer is canceled.

- After TIMER setting, if ON/OFF button is pressed before the setting time, TIMER display turns off and the TIMER is canceled.

- **Time change**

- Press OFF TIMER button to set again.

7. SLEEP TIMER OPERATION

The operation stops at the specified time.

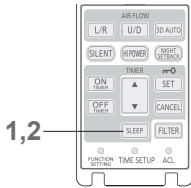

[EXAMPLE] If you would like to stop the operation 12 hours later

1. Press SLEEP button.

The OFF TIMER indicator LED **OFF** lights up. "1H" is displayed.
The timer/check indicator LED lights up on the remote control signal receiver.

2. The display changes as shown below each time the SLEEP button is pressed.

The display changes as follows: 1H → 2H → 3H (one hour increment) → 10H → 11H → 12H → Sleep timer reset → 1H → 12H.

By stopping at 12H, operation stops after 12 hours.

● Cancellation

- If you press the SLEEP button or CANCEL button, the timer display disappears and the timer is canceled.
- If you press the RUN/STOP button before the specified time is reached, the timer display disappears and the timer is canceled.

● Changing the set time

- Press SLEEP button to set again.

8. PROGRAM TIMER OPERATION

By setting both ON TIMER and OFF TIMER, the settings turn into PROGRAM timer mode. Operation and stopping can be performed at the same time every day by setting program timer once.

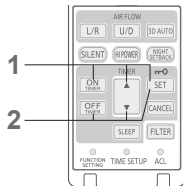

1. Set ON TIMER.

Press ON TIMER button and set the time with ▼ or ▲ button.
Press SET button.

2. Set OFF TIMER.

Press OFF TIMER button and set the time with ▼ or ▲ button.
Press SET button.

Both ON TIMER and OFF TIMER are displayed. The direction of arrow mark changes depending on the status of operation.

ON (stop) **ON** (operating)

If the same time is set for the ON TIMER and OFF TIMER, **OFF** is displayed, which makes the program timer stop the operation at the same time every day.

● Cancellation

- Press CANCEL button to turn off the PROGRAM timer display and timer is canceled. (Operation condition is kept as before the button is pressed.)
- If ON/OFF button is pressed during TIMER operation, TIMER display turns off and the TIMER is canceled. The air conditioner stops operating.

● Changing the set time

- Press OFF TIMER button or ON TIMER button to set again.

9. INDOOR FUNCTION SETTINGS (Available only with master wireless receiver)

This user's manual describes how to set the indoor unit functions after installation (power-on) has been completed.

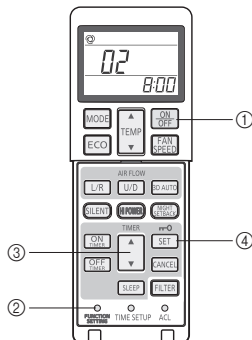

1. How to set indoor functions

- ① Press the ON/OFF button to stop the unit.
- ② Press the desired one of the buttons shown item 2 while holding down the FUNCTION SETTINGS switch.
- ③ Use the selection buttons, ▲ and ▼, to change the setting.
- ④ Press the SET button.

The buzzer on the remote control signal receiver beeps twice, and the LED lamp blinks four times at two-second intervals.

2. Setting details

The following functions can be set.

Button	Number indicator	Function setting
FAN SPEED	00	Fan speed setting : Standard
	01	Fan speed setting : Setting 1 *1
	02	Fan speed setting : Setting 2 *1
MODE	00	Room heating temperature adjustment : Disable
	01	Room heating temperature adjustment : +1°C
	02	Room heating temperature adjustment : +2°C
	03	Room heating temperature adjustment : +3°C
FILTER	00	Filter sign display : OFF
	01	Filter sign display : 180 hours
	02	Filter sign display : 600 hours
	03	Filter sign display : 1000 hours
U/P	00	Anti draft setting : Disable
	01	Anti draft setting : Enable
SILENT	00	Infrared sensor setting (Motion sensor setting) : Disable
	01	Infrared sensor setting(Motion sensor setting) : Enable
HI POWER	00	Infrared sensor control(Motion sensor control) : Disable
	01	Infrared sensor control(Motion sensor control) : Power control only
	02	Infrared sensor control(Motion sensor control) : Auto OFF only
	03	Infrared sensor control(Motion sensor control) : Power control and Auto OFF
ON TIMER	00	Cooling fan residual-period running : Disable
	01	Cooling fan residual-period running : 0.5 hours
	02	Cooling fan residual-period running : 2 hours
	03	Cooling fan residual-period running : 6 hours
OFF TIMER	00	Heating fan residual-period running : Disable
	01	Heating fan residual-period running : 0.5 hours
	02	Heating fan residual-period running : 2 hours
	03	Heating fan residual-period running : 6 hours
NIGHT SETBACK	00	Remote control signal receiver LED: Brightness High *2
	01	Remote control signal receiver LED: Brightness Low *2
	02	Remote control signal receiver LED : OFF *2

*1 Refer to technical data.

*2 Can also be set with slave wireless receiver.

NOTICE

- When indoor function settings are changed, all indoor function settings will be transmitted together. The settings for all functions, even those that have not been changed, are overwritten with the settings stored in the wireless remote control. Therefore, be careful when using a single remote control to change the indoor function settings for multiple receivers.
- When the setting is "Anti draft setting : Enable", the remote control signal may be interfered by Anti draft device and may not be received. In this case, move to a position where the remote control signal can be received.

10. BACKUP SWITCH OPERATION

If the batteries are exhausted, or the remote control is malfunctioning or lost, you can use the BACK UP switch on the display section on the body to run or stop the air conditioner as an emergency measure.

ON/OFF

- Press the BACKUP switch described in "2. NAMES AND FUNCTIONS OF REMOTE CONTROL BUTTON" (page 4) and release it in two seconds or less. The operation starts.
- When you press this button again, the operation stops.

OPERATION MODE	ⓐ(AUTO)
SET TEMPERATURE	23°C
FAN SPEED	3-speed
SWING	STOP
ON TIMER/OFF TIMER	Invalid

11. CHECK INDICATION

If the following LED blinks or any code appears on the monitor display, it indicates that an error has occurred in the air conditioner. Please contact your dealer and inform them "address No. and check code", "symptom of the trouble", "air conditioner type" and "model name" etc. Press the ON/OFF button to stay the air conditioner on the stop mode.

■ Ceiling suspended (FDE)

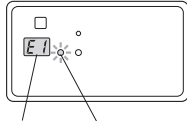

CHECK MODE INDICATOR TIMER/CHECK LED

■ Ceiling cassette -4 way- (FDT)

■ Ceiling cassette -4 way Compact- (FDTC)

■ Ceiling cassette -1 way- (FDTS)

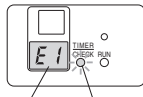

CHECK MODE INDICATOR TIMER/CHECK LED

For FDE, FDT, FDTC, or FDTS

- The TIMER/CHECK LED blinks (stays on for 0.5 seconds and shuts off for 0.5 seconds), and the air conditioner stops simultaneously.
- Address No. is displayed on the CHECK MODE INDICATOR, check code display after address No. turns off.
- The monitor display turns off when the display time lapses.
- If no codes are displayed on the monitor, operate the remote control or press the BACK UP switch.

■ RCN-KIT4-E2

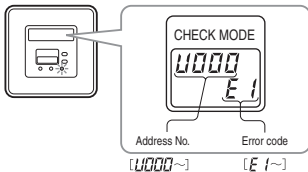

For RCN-KIT4-E2

- The RUN/CHECK LED blinks (stays on for 0.5 seconds and shuts off for 0.5 seconds), and the air conditioner stops simultaneously.
- Address No. and check code are displayed on the check mode indicator.
- The monitor display turns off when the display time lapses.
- If no codes are displayed on the monitor, operate the remote control or press the BACK UP switch.

■ Ceiling cassette -2 way- (FDTW)

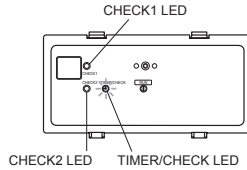

CHECK2 LED TIMER/CHECK LED

■ Floor standing -2way- (FDFW)

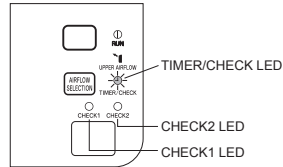

For FDTW, FDFW

- The TIMER/CHECK LED blinks (stays on for 0.5 seconds and shuts off for 0.5 seconds), and the air conditioner stops simultaneously.
- Only the number that corresponds to the "tens place" or "ones place" of the error code on the "CHECK 1" or "CHECK 2" indicator LED blinks (10 seconds per cycle).
- To indicate an error code, the LED blinks as shown below.

Example: For E39

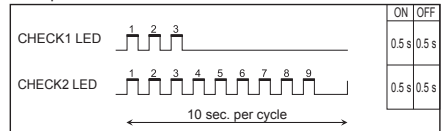

■ Wall mounted (FDK)

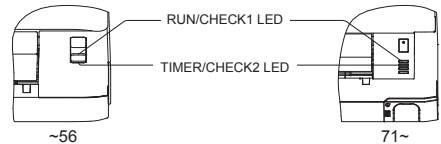

For FDK

- Only the number that corresponds to the "tens place" or "ones place" of the error code on the RUN/CHECK1 LED or TIMER/CHECK2 LED blinks (10 seconds per cycle), and the air conditioner stops simultaneously.
- To indicate an error code, the LED blinks as shown below.

Example: For E39

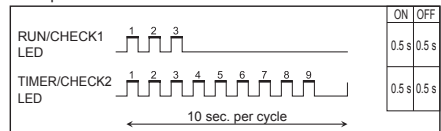

12. FILTER SIGN

If the FILTER SIGN LED blinks as shown below, clean the filter.

■ Ceiling suspended (FDE)

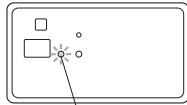

TIMER/CHECK LED

■ Ceiling cassette (FDT)

■ Ceiling cassette-4 way Compact (FDTC)

■ Ceiling cassette (FDTS)

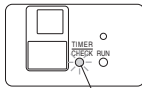

TIMER/CHECK LED

■ Floor standing -2way- (FDFW-KXE6)

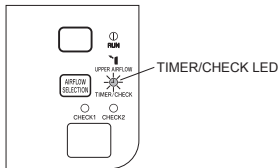

TIMER/CHECK LED

■ Ceiling cassette (FDTW)

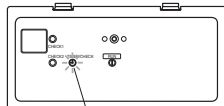

TIMER/CHECK LED

For FDE, FDT, FDTC, FDTS or FDTW

- The TIMER/CHECK LED long-blinks (stays on for two seconds and shuts off for one second).
- When filter cleaning is complete, press the FILTER button on the remote control to reset the filter.

■ Wall mounted (FDK)

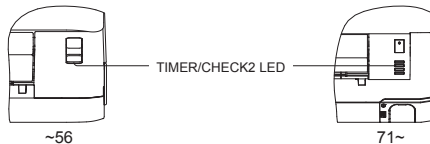

TIMER/CHECK2 LED

~56

71~

For FDK

- The TIMER/CHECK2 LED long-blinks (stays on for two seconds and shuts off for one second).
- When filter cleaning is complete, press the FILTER button on the remote control to reset the filter.

■ RCN-KIT4-E2

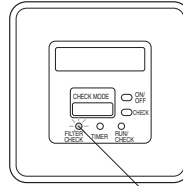

FILTER SIGN LED

For RCN-KIT4-E2

- The FILTER SIGN LED long-blinks (stays on for two seconds and shuts off for one second).
- When filter cleaning is complete, press the FILTER button on the remote control to reset the filter.

NOTICE

The FILTER SIGN setting time can be changed in the indoor function setting. The default is set to 180 hours.



mitsubishi heavy industries thermal system, ltd.

16-5, Konan 2-chome, Minato-ku, Tokyo, 108-8215, Japan
<http://www.mhi-mth.co.jp>

mitsubishi heavy industries air-conditioning europe, ltd.

7 Roundwood Avenue, Stockley Park, Uxbridge, Middlesex, UB11 1AX, United Kingdom
Tel : +44-20-7025-2750
Fax : +44-20-7025-2751
<http://www.mhiaa.com>

mitsubishi heavy industries air - conditioners australia, Pty. Ltd.

9C Commercial Road Kingsgrove NSW 2208 PO BOX 318 Kingsgrove NSW 1480
Tel : +61-2-8571-7977
Fax : +61-2-8571-7992
<http://www.mhiaa.com.au>

mitsubishi heavy industries - MAHAJAK AIR CONDITIONERS CO., LTD.

220, Soi Chalongkrung 31,
Kwang Lamplatiew, Khet Lad Krabang, Bangkok 10520, Thailand
Tel : +66-2-326-0401
Fax : +66-2-326-0419
<http://www.maco.co.th/>